

WOODFOX[®]
ENJOY WOODWORKING

2023

德冠工業有限公司

Precision fastener Systems



Woodfox Tools Co.,Ltd



德冠工業有限公司

Satisfy Innovation Improve

If you are a woodworking enthusiast or a seasoned professional looking for a strong, efficient and economical solution to joinery then WoodFox has it covered.

WoodFox manufactures a complete range of high quality and innovative joinery jigs and accessories that are raising the bar in the field of pocket hole joinery, the new and exciting range of WoodFox jigs are manufactured to the highest standards, are designed for simple operation and most crucially allow rapid set up and repeatability ensuring maximum accuracy and time saving.

The WoodFox pocket hole jig is designed to allow the accurate drilling of side by side pocket holes on both new projects and repairs. Its unique magnetic quick adjust system makes setting up the jig a rapid and simple operation, without doubt one of the simplest and most efficient pocket hole jig systems available today.

We have been expanding our business operations around the world as a leading professional manufacturer and sell all kinds of woodworking tools product in Taiwan.

A reason our growth is largely and we are focus on manufacturing and woodworking tools development design and innovation.

We endue the innovation and passion for the products.

We believe that if you give us any opportunity to deal in your products.

We will be keep passion and provide high quality products and service to you.

We are looking forward to establishing long-term mutual benefit in the near future and your partnership



Single Pocket Hole Jig

WF-MP1H4



Pocket hole jig system of One hole
High hardened plastic body parts.
High hardened metal drill guide.
Easy to use and quickly remove for install
Adjust for wood materials from 1/2" to 1-1/2"
Top side magnetic for steel C clamp.
Easy to set drill depth and tighten.

Contents:
One hole jig
3/8" Hss Step Drill Bit
Depth Stop Collar
Allen Wrench
Packing: PET blister + Card



Single Pocket Hole Jig

WF-TP1H4



Pocket hole jig system of One hole
High hardened plastic body parts.
High hardened metal drill guide.
Easy to use and quickly remove for install
Adjust for wood materials from 1/2" to 1-1/2"
Easy to set drill depth and tighten.

Contents:
One hole jig
3/8" Hss Step Drill Bit
Depth Stop Collar
Allen Wrench
Packing: PET blister + Card

Twin Pocket Hole Jig

WF-MP2H4



Pocket hole jig system of Twin holes
High hardened plastic body parts.
High hardened metal drill guide.
Easy to use and quickly remove for install
Adjust for wood materials from 1/2" to 1-1/2"
Top side magnetic for steel C clamp.
Easy to set drill depth and tighten.

Contents:
Two holes jig
3/8" Hss Step Drill Bit
Depth Stop Collar
Allen Wrench
Packing: PET blister + Card



Twin Pocket Hole Jig

WF-MP2HK

Pocket hole jig system of Twin holes
 High hardened plastic body parts
 High hardened metal drill guide
 Easy to use and quickly remove for install
 Adjust for wood materials from 1/2" to 1-1/2"
 Top side magnetic for steel C clamp
 Easy to set drill depth and tighten



Contents:

- Twin holes jig
 - 3/8" Hss Step Drill Bit
 - Square Driver 150mm Bit No.2 Robertson
 - Depth Stop Collar
 - Allen Wrench
 - #7 1 Coarse Square Driver Screws with Pan-Head x10pcs
 - #8 1-1/4 Coarse Square Driver Screws with Washer-Head x10pcs
 - #8 1-1/2 Coarse Square Driver Screws with Washer-Head x10pcs
 - #8 2 Coarse Square Driver Screws with Washer-Head x10pcs
 - #8 2-1/2 Coarse Square Driver Screws with Washer-Head x10pcs
- Packing: Black P.P Box+Clear cover +Sleeve Card

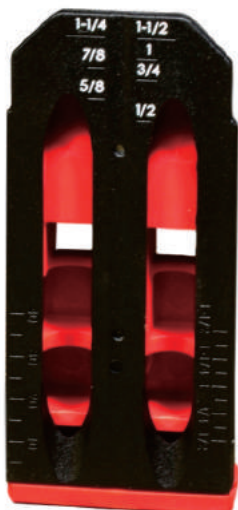

Adjustable Pocket Hole Jig

WF-TP2H4



Adjustable Hole Pitch

Pocket hole jig system of Twin holes
High hardened plastic body parts.
High hardened metal drill guide.
Easy to use and quickly remove for install
Adjust for wood materials from 1/2" to 1-1/2"
Top side magnetic for steel C clamp.
Easy to set drill depth and tighten.

Contents:
Two holes jig
3/8" Hss Step Drill Bit
Depth Stop Collar
Allen Wrench
Packing: PET blister + Card

Adjustable Pocket Hole Jig Kit

WF-TP2HK



3 In 1 Pocket Hole Jig Adjustable Hole Pitch

Pocket hole jig system of Twin holes
High hardened plastic body parts
High hardened metal drill guide
Easy to use and quickly remove for install
Adjust for wood materials from 1/2" to 1-1/2"
Top side magnetic for steel C clamp
Easy to set drill depth and tighten

Contents:
Adjustable Twin hole jig
3/8" Hss Step Drill Bit
Square Driver 150mm Bit No.2 Robertson
Depth Stop Collar
Allen Wrench
#7 1 Coarse Square Driver Screws with Pan-Head x10pcs
#8 1-1/4 Coarse Square Driver Screws with Washer-Head x10pcs
#8 1-1/2 Coarse Square Driver Screws with Washer-Head x10pcs
#8 2 Coarse Square Driver Screws with Washer-Head x10pcs
#8 2-1/2 Coarse Square Driver Screws with Washer-Head x10pcs
Packing: Black P.P Box+Clear cover +Sleeve Card



Changeable to Single Pocket Hole Jig

Aluminum Pocket Hole Jig

WF-AP2HK

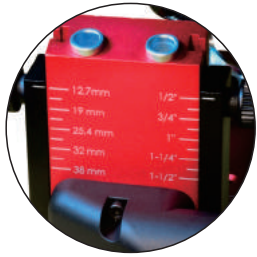

Adjustable height columns for different thickness



Drill depth turret for setting up

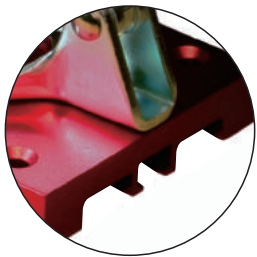

T solt for Groove clamp

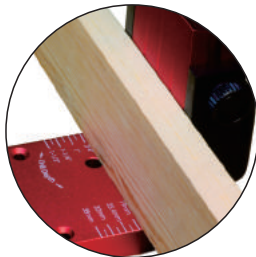

Scale on the jig for measurement

Professional Pocket hole jig system of Twin holes
High hardened aluminum material body parts
High hardened metal drill guide
Easy to use and quickly remove for install
Adjust for wood materials from 1/2" to 1-1/2"
Easy to set drill depth and tighten

Contents:

- Twin Holes Aluminum Jig
- Dust Extraction Coupling
- Drill Setting Turret
- Material End Plate (For Mobile Use)
- 3/8" Hss Step Drill Bit
- Square Driver 150mm Bit No.2 Robertson
- Depth Stop Collar
- Hex Wrench (For Depth Stop Collar Use)
- Hex Wrench (For Mobile Use)
- 4 x Bench Fixing Screws
- #7 1 Coarse Square Driver Screws with Pan-Head x10pcs
- #8 1-1/4 Coarse Square Driver Screws with Washer-Head x10pcs
- #8 1-1/2 Coarse Square Driver Screws with Washer-Head x10pcs
- #8 2 Coarse Square Driver Screws with Washer-Head x10pcs
- #8 2-1/2 Coarse Square Driver Screws with Washer-Head x10pcs
- Instruction Manual
- Box Packaging

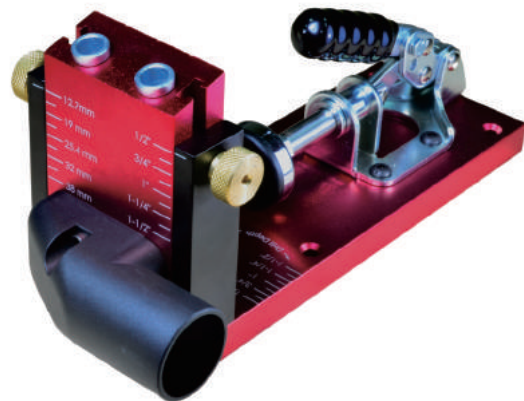

Technical Specifications

Material thickness : 12.7 mm(1/2")~38 mm(1-1/2")
Drill bit size : 9.5 mm(3/8")
Square driver bit : No.2x150 mm(6")
Hole pitch : 30mm(1-3/16")
Dust port : Internal 31mm(1-1/4")

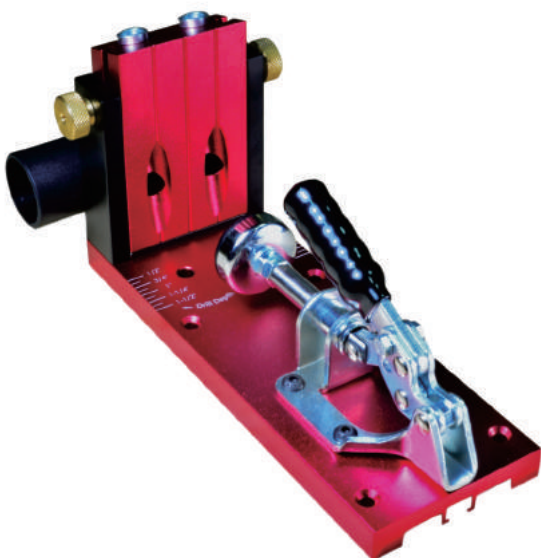

WF-AP3HK

Triple Holes Pocket Hole Jig



Aluminum Pocket Hole Jig

WF-AP4HK



**Drill depth turret
for setting up**

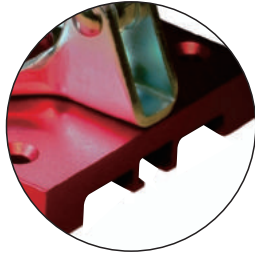

**T slot for
Groove clamp**

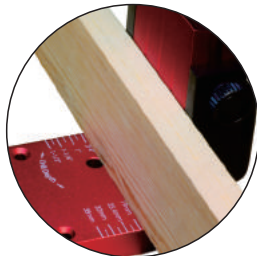

**Scale on the jig for
measurement**

Professional Pocket hole jig system of four holes
High hardened aluminum material body parts
High hardened metal drill guide
Easy to use and quickly remove for install
Adjust for wood materials from 1/2" to 1-1/2"
Easy to set drill depth and tighten

Contents:

- Twin Holes Aluminum Jig
- Dust Extraction Coupling
- Drill Setting Turret
- Material End Plate (For Mobile Use)
- 3/8" Hss Step Drill Bit
- Square Driver 150mm Bit No.2 Robertson
- Depth Stop Collar
- Hex Wrench (For Depth Stop Collar Use)
- Hex Wrench (For Mobile Use)
- 4 x Bench Fixing Screws**
- #7 1 Coarse Square Driver Screws with Pan-Head x10pcs
- #8 1-1/4 Coarse Square Driver Screws with Washer-Head x10pcs
- #8 1-1/2 Coarse Square Driver Screws with Washer-Head x10pcs
- #8 2 Coarse Square Driver Screws with Washer-Head x10pcs
- #8 2-1/2 Coarse Square Driver Screws with Washer-Head x10pcs
- Instruction Manual
- Box Packaging

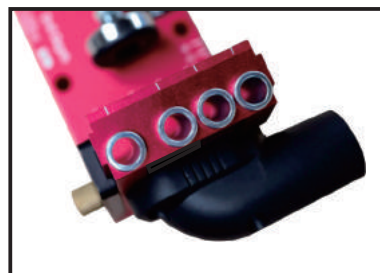
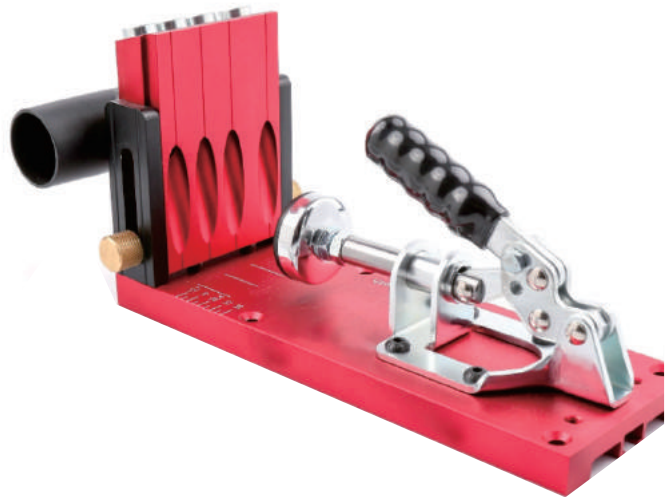
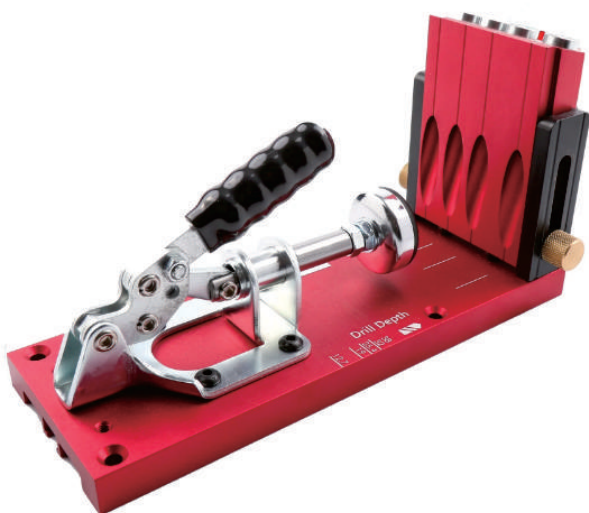

Four Holes Pocket Hole Jig

ACCESSORIES

WF-MPDB

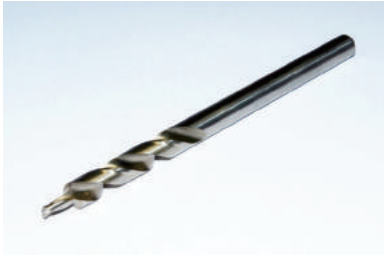

3/8" Hss Step Drill Bit

Made specifically for Pocket-Screw Joinery.

High quiality hardened steel for longevity.

Recommended for use with corded high-rpm drills

Product Dimensions : 3/8" x 6-1/4" L

Color : Silver metallic

Material : Hss Steel

WF-MPDBT



3/8" Hss Step Drill Bit (1/4-Impact)

Made specifically for Pocket-Screw Joinery.

1/4" hex shank works with any quick change chuck.

Hex shank with power groove resists slippage.

High quality hardened steel for longevity.

Recommended for use with corded high-rpm drills

Product Dimensions : 3/8" x 6-1/4" L

Color : Silver metallic

Material : Hss Steel

WF-MPSD



Square Driver 150mm Bit No.2 Robertson

Made specifically for Pocket-Screw Joinery.

1/4" hex shank works with any quick change chuck.

Drivers come in standard version

Product Dimensions : 6" L

Color : Sandblast

Material : S2 Steel

(Pack of 2)

SCREWS

High quality zinc plated pocket hole screws featuring a gash point for easy installation. These screws are supplied pan head with a Robertson No2 square drive recess ensuring maximum engagement between the driver bit and screw which results in effortless insertion.

Fine-Thread

- #6 1 Fine Square Driver Screws with PAN-Head
- #7 1-1/4 Fine Square Driver Screws with Washer-Head

Coarse-Thread

- #7 1 Coarse Square Driver Screws with PAN-Head
- #8 1-1/4 Coarse Square Driver Screws with Washer-Head
- #8 1-1/2 Coarse Square Driver Screws with Washer-Head
- #8 2 Coarse Square Driver Screws with Washer-Head
- #8 2-1/2 Coarse Square Driver Screws with Washer-Head

WOODFOX® Pocket-Hole Screws			
Recommend Screw Length for Joinery			
Self-Tapping	#2 Square Driver	Pan Head	Washer Head
Fine-Thread for Hardwoods Ash, Maple, Hickory, Oak, Walnut, Cherry, Birch, Etc.	1/2" - 5/8" (13mm - 16mm)	1" (25mm)	Material Thickness
	3/4" (19mm)	1-1/4" (32mm)	
Coarse-Thread for Softwoods Plywood, Particle board, MDF, Melamine, Aspen, Pine, Cedar, Etc.	7/8" - 1-1/8" (22mm - 29mm)	1-1/2" (38mm)	Material Thickness
	1-1/4" - 1-3/8" (32mm - 35mm)	2" (51mm)	
	1-1/2" (38mm)	2-1/2" (64mm)	



WF-PBSK

Supplied in PP Plastic Boxes (Each Size)

Fine-Thread

- #6X1" Fine Thread X 200
- #7X1-1/4" Fine Thread X 150

Coarse-Thread

- #7X1" Coarse Thread X 200
- #8X1-1/4" Coarse Thread X 150
- #8X1-1/2" Coarse Thread X 150
- #8X2" Coarse Thread X 100
- #8X2-1/2" Coarse Thread X 100

Plastic Box Screw Series (Overlapping Design)

WF-850SK

Supplied in kit boxes of 850 screws.

Contains of 7 Screw Sizes

Fine-Thread

- #6X1" Fine Thread X 200
- #7X1-1/4" Fine Thread X 100

Coarse-Thread

- #7X1" Coarse Thread X 200
- #8X1-1/4" Coarse Thread X 125
- #8X1-1/2" Coarse Thread X 75
- #8X2" Coarse Thread X 75
- #8X2-1/2" Coarse Thread X 75



Clamps

WF-MPFCP

3" Face Clamp (For Pocket Hole Use)



Quick release action and secure lock for drill work
The face clamp with opening clamp to 75mm
Designed innovation feature for pocket hole jig systems
Comfortable pvc grip handle with red/black color



WF-HDCP

Hold-Down Clamp

T-bolt 5/16" x 3-1/2" long-18 thread
High quality aluminum alloy body
High-tension clamping capacity
Handy 5-star knob design



Concealed Decking Jig

WF-DKJ



Deck board capacity from 90~150mm thick.
 Easy installation ,handle quickly relaease clamp system.
 Highly strength Nylon plastic body.
 Zinc material in jig body.
 Torx-15 head drive bit.
 Deck gap between of 3.5/4.5 and 5.5mm
 Iron sheet 1mm/2mm

WF-DT15



Torx-15 head drive bit x4" (100mm) Length
 S2 material

WF-RT60S



Hidden Decking Screw

Self-drill thread decking screw
 Torx-15 Head Bit
 C1022 material
 Decking Screw 4.5x60mm Head 5mmx3mm
 Outdoor Ruspert Coated Screws (Silver)
 Salt spray test 1000Hours

35MM Concealed Hinge Jig

WF-HGJ

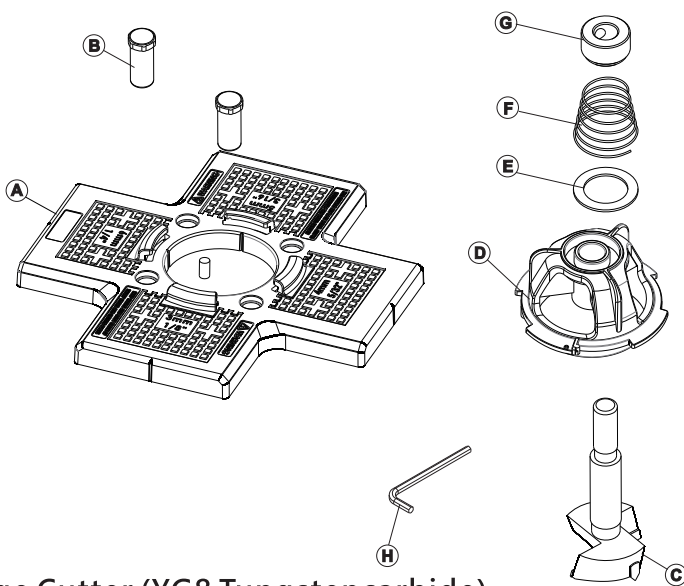
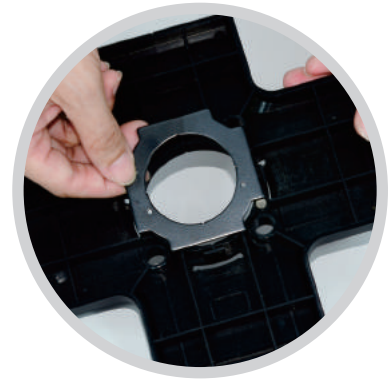
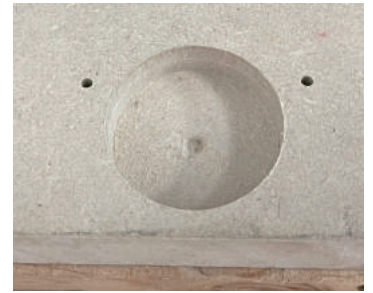

Parts

- (A) Jig Body
- (B) Pin
- (C) 35mm Hinge Cutter
- (D) Cap
- (E) Washer
- (F) Spring
- (G) Depth Stop Collar
- (H) Hex Wrench

35mm Hinge Cutter (YG8 Tungstencarbide)
Distance from 3,4,5 and 6mm.
Quickly rotate installation system.
Highly strength Nylon plastic body.
Iron sheet 2mm



WOODFOX®
ENJOY WOODWORKING

德冠工業有限公司

Woodfox Tools Co., Ltd

No.28 His Chou West Rd Tai Ping Dist Taichung City 41163 Taiwan
No.3 & No.5-207, Dayuan 19th Street, Taiping, Taichung City, Taiwan

Te l: +886-4-23936071

Fax: +886-4-22774467

E-mail: woodfoxtool@gmail.com

<http://www.woodfox.com.tw>